

794184-1 ✓ ACTIVE

MATE-N-LOK | Mini-Universal MATE-N-LOK 2

TE Internal #: 794184-1

Rectangular Power Connectors, Housing, Plug, Wire-to-Board /

Wire-to-Wire, 2 Position, 4.14 mm [.162 in] Centerline, Mini-

Universal MATE-N-LOK 2

[View on TE.com >](#)



Connectors > Power Connectors > Rectangular Power > Rectangular Power Connectors

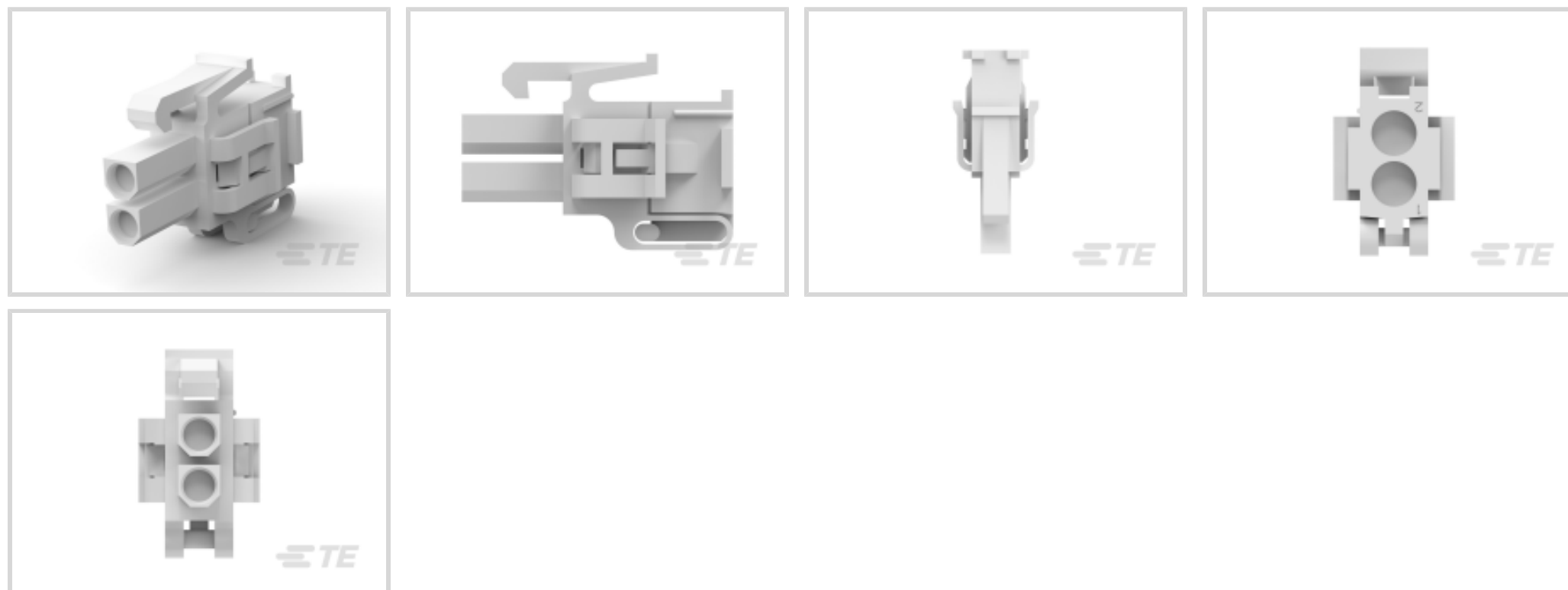

Rectangular Power Connector Type: **Housing**

Connector & Housing Type: **Plug**

Connector System: **Wire-to-Board, Wire-to-Wire**

Number of Positions: **2**

Centerline (Pitch): **4.14 mm [.162 in]**

## Features

### Product Type Features

Rectangular Power Connector Type	Housing
Connector & Housing Type	Plug
Connector System	Wire-to-Board, Wire-to-Wire
Sealable	No
Connector & Contact Terminates To	Wire & Cable

### Configuration Features

Number of Positions	2
Number of Rows	1

### Electrical Characteristics

Operating Voltage	600 VDC
-------------------	---------

### Contact Features

Multiple Contact Types	Without
Contact Layout	Inline
Contact Retention Within Housing	Without



Contact Type	Socket
--------------	--------

### Termination Features

Termination Method to Wire & Cable	Crimp
------------------------------------	-------

### Mechanical Attachment

Panel Mount Feature	Without
---------------------	---------

Connector Mounting Type	Cable Mount (Free-Hanging)
-------------------------	----------------------------

### Housing Features

Centerline (Pitch)	4.14 mm [.162 in]
--------------------	-------------------

Housing Color	Natural
---------------	---------

Housing Material	Nylon
------------------	-------

### Usage Conditions

Operating Temperature Range	-55 – 105 °C [-67 – 221 °F]
-----------------------------	-----------------------------

### Operation/Application

Assembly Integration Feature	Without
------------------------------	---------

Circuit Application	Power & Signal
---------------------	----------------

### Industry Standards

UL Flammability Rating	UL 94V-0
------------------------	----------

Glow Wire Rating	Standard Part - Not Glow Wire
------------------	-------------------------------

UL Rating	Recognized
-----------	------------

Agency/Standard Number	E28476
------------------------	--------

VDE Tested	No
------------	----

Agency/Standard	UL
-----------------	----

### Packaging Features

Packaging Method	Bag
------------------	-----

Packaging Quantity	800
--------------------	-----

### Other

For Use With	Mini-Universal MATE-N-LOK 2 Cap Housing /PC Board Pin Headers Header
--------------	--

### Product Compliance

For compliance documentation, visit the product page on [TE.com](https://www.te.com)>

EU RoHS Directive 2011/65/EU	Compliant
------------------------------	-----------









EU ELV Directive 2000/53/EC	Compliant
China RoHS 2 Directive MIIT Order No 32, 2016	No Restricted Materials Above Threshold
EU REACH Regulation (EC) No. 1907/2006	Current ECHA Candidate List: JUNE 2022 (224) Candidate List Declared Against: JUNE 2022 (224) Does not contain REACH SVHC
Halogen Content	Low Halogen - Br, Cl, F, I < 900 ppm per homogenous material. Also BFR/CFR/PVC Free
Solder Process Capability	Not applicable for solder process capability

Product Compliance Disclaimer

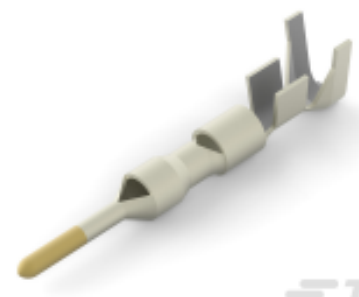
This information is provided based on reasonable inquiry of our suppliers and represents our current actual knowledge based on the information they provided. This information is subject to change. The part numbers that TE has identified as EU RoHS compliant have a maximum concentration of 0.1% by weight in homogenous materials for lead, hexavalent chromium, mercury, PBB, PBDE, DBP, BBP, DEHP, DIBP, and 0.01% for cadmium, or qualify for an exemption to these limits as defined in the Annexes of Directive 2011/65/EU (RoHS2). Finished electrical and electronic equipment products will be CE marked as required by Directive 2011/65/EU. Components may not be CE marked. Additionally, the part numbers that TE has identified as EU ELV compliant have a maximum concentration of 0.1% by weight in homogenous materials for lead, hexavalent chromium, and mercury, and 0.01% for cadmium, or qualify for an exemption to these limits as defined in the Annexes of Directive 2000/53/EC (ELV). Regarding the REACH Regulation, the information TE provides on SVHC in articles for this part number is based on the latest European Chemicals Agency (ECHA) 'Guidance on requirements for substances in articles' posted at this URL: <https://echa.europa.eu/guidance-documents/guidance-on-reach>

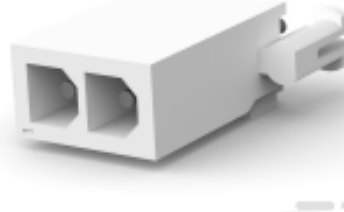
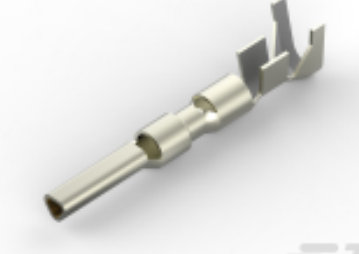
## Compatible Parts

 <p>TE Part # 770966-2 02P MINI UMNL R/A HDR ASSY AU</p>	 <p>TE Part # 770166-2 02P MINI-UMNL ASSY VO SNAU</p>	 <p>TE Part # 1-794228-0 MINI UMNL2 PIN 22-18 AWG AU LP</p>	 <p>TE Part # 770166-1 02P MINI-UMNL ASSY VO SNNI*</p>
 <p>TE Part # 794224-1 MINI UMNL2 PIN 30-26 AWG SN LP</p>	 <p>TE Part # 1-770872-0 02P MINI UMNL HDR ASSY SN</p>	 <p>TE Part # 794229-3 MINI UMNL2 SOK 22-18 AWG AU LP</p>	 <p>TE Part # 1-770166-0 02P MINI-UMNL ASSY VO SNNI*</p>



Also in the Series | **Mini-Universal MATE-N-LOK 2**

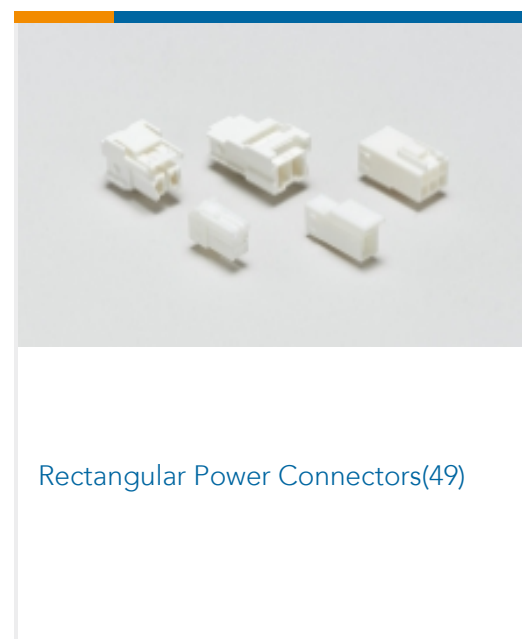
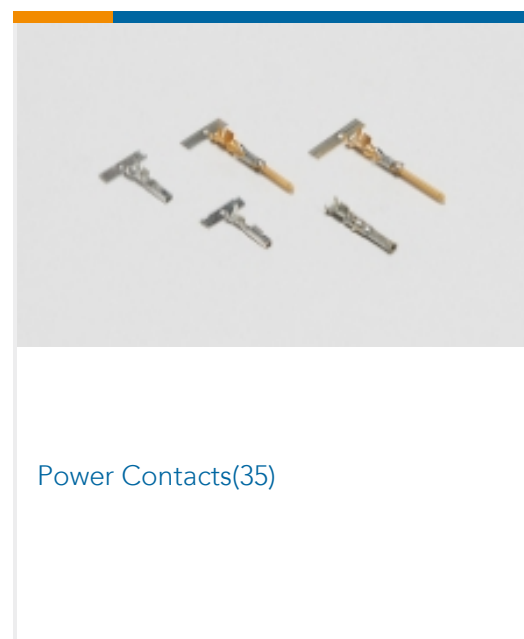
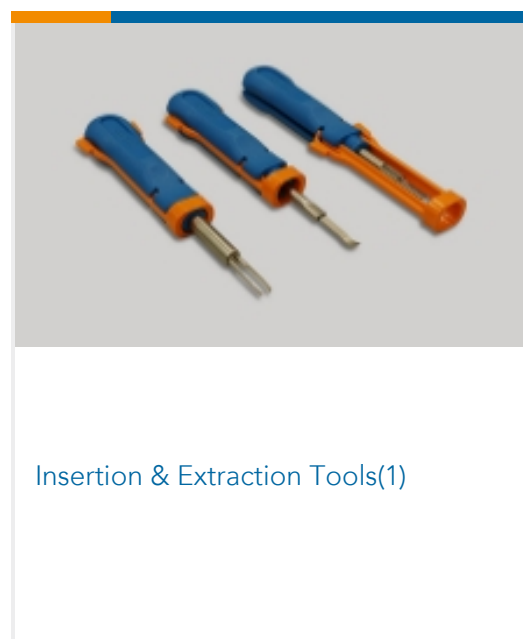
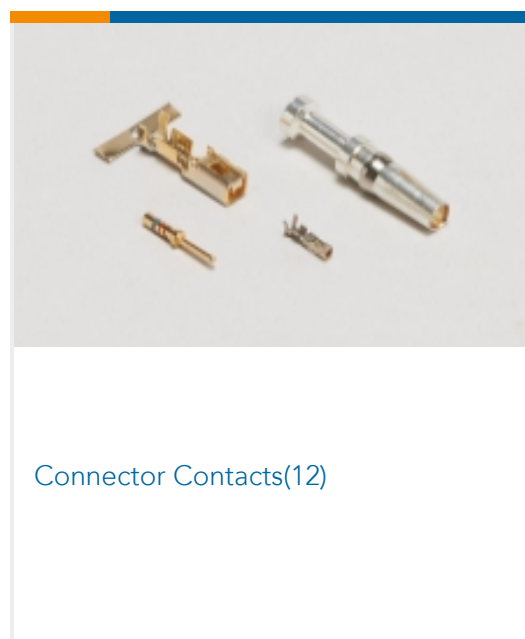

Documents

**Product Drawings**

02P MINI UMNL2 PLUG HSG UL94V0

English

**CAD Files**

3D PDF

3D

Customer View Model



[ENG\\_CVM\\_CVM\\_794184-1\\_J.2d\\_dxf.zip](#)

English

**Customer View Model**

[ENG\\_CVM\\_CVM\\_794184-1\\_J.3d\\_igs.zip](#)

English

**Customer View Model**

[ENG\\_CVM\\_CVM\\_794184-1\\_J.3d\\_stp.zip](#)

English

By downloading the CAD file I accept and agree to the [Terms and Conditions](#) of use.

---

### Datasheets & Catalog Pages

[SOFT\\_SHELL\\_PIN\\_AND\\_SOCKET\\_CONNECTORS\\_CATALOG](#)

English

---

### Product Specifications

[Application Specification](#)

English

---

### Product Environmental Compliance

[MD\\_794184-1\\_06112018727\\_dmtec](#)

English

[MD\\_794184-1\\_06112018727\\_dmtec](#)

English

---

### Instruction Sheets

[Instruction Sheet \(U.S.\)](#)

English